



IP-7000H-TX

1G 4K AV over IP HDMI Transmitter with USB & PoE

OPERATION MANUAL

HDMI[®]
HIGH-DEFINITION MULTIMEDIA INTERFACE

The terms HDMI, HDMI High-Definition Multimedia Interface, and the HDMI Logo are trademarks or registered trademarks of HDMI Licensing Administrator, Inc.

DISCLAIMERS

The information in this manual has been carefully checked and is believed to be accurate. CYP (UK) Ltd assumes no responsibility for any infringements of patents or other rights of third parties which may result from its use.

CYP (UK) Ltd assumes no responsibility for any inaccuracies that may be contained in this document. CYP (UK) Ltd also makes no commitment to update or to keep current the information contained in this document.

CYP (UK) Ltd reserves the right to make improvements to this document and/or product at any time and without notice.

COPYRIGHT NOTICE

No part of this document may be reproduced, transmitted, transcribed, stored in a retrieval system, or any of its part translated into any language or computer file, in any form or by any means—electronic, mechanical, magnetic, optical, chemical, manual, or otherwise—without express written permission and consent from CYP (UK) Ltd.

© Copyright 2020 by CYP (UK) Ltd.

All Rights Reserved.

Version 1.1

TRADEMARK ACKNOWLEDGMENTS

All products or service names mentioned in this document may be trademarks of the companies with which they are associated.



SAFETY PRECAUTIONS

Please read all instructions before attempting to unpack, install or operate this equipment and before connecting the power supply. Please keep the following in mind as you unpack and install this equipment:

- Always follow basic safety precautions to reduce the risk of fire, electrical shock and injury to persons.
- To prevent fire or shock hazard, do not expose the unit to rain, moisture or install this product near water.
- Never spill liquid of any kind on or into this product.
- Never push an object of any kind into this product through any openings or empty slots in the unit, as you may damage parts inside the unit.
- Do not attach the power supply cabling to building surfaces.
- Use only the supplied power supply unit (PSU). Do not use the PSU if it is damaged.
- Do not allow anything to rest on the power cabling or allow any weight to be placed upon it or any person walk on it.
- To protect the unit from overheating, do not block any vents or openings in the unit housing that provide ventilation and allow for sufficient space for air to circulate around the unit.
- Please completely disconnect the power when the unit is not in use to avoid wasting electricity.

VERSION HISTORY

REV.	DATE	SUMMARY OF CHANGE
RDV1	2022/09/14	Preliminary release

CONTENTS

1. Introduction	1
2. Applications	2
3. Package Content	2
4. System Requirements	2
5. Features	3
6. Operation Controls and Functions	4
6.1 Transmitter's Front Panel	4
6.2 Transmitter's Rear Panel	6
6.3 IR Cable Pinouts	7
6.4 Serial Pinout and Defaults	7
6.5 WebGUI Control	8
6.5.1 System Tab	10
6.5.2 Video Wall Tab	13
6.5.3 Network Tab	17
6.5.4 Functions Tab	19
6.6 Telnet Control	22
6.7 Serial and Telnet Commands	22
7. Connection Diagram	32
8. Specifications	33
8.1 Technical Specifications	33
8.2 Video Specifications	35
8.3 Audio Specifications	37
8.3.1 Digital Audio	37
8.3.2 Analogue Audio	37
8.3.3 AVoIP Audio Availability	38
8.4 Cable Specifications	39
9. Acronyms	40



1. INTRODUCTION

The IP-7000H-TX is the latest 1G AV over IP Transmitter, with industry standard HDMI, RS232, IR, Analogue audio & USB inputs connectivity is straightforward.

The IP-7000 series allows installers to configure a unique signal distribution system via a dedicated IT Network Infrastructure. You are in control when deciding how many inputs and end-points you require from the system; whether it be one transmitter to many receivers or many too many, your possibilities are endless. Using the IP-A750TX & RX you can add even audio only zones. Simplicity is at the core of the IP-7000 as both the transmitter and receiver support PoE.

The video and audio can be transmitted via an IP network for distances up to 100m through a single network switch. The transmission distance can be further extended up to 100m between network switches and supports Gigabit networks.

This system also features bi-directional IR pass-through, analogue line level in/out, and microphone input provide the user with variety of audio options. The USB function allows the system to act like USB hub which, when combined with the VGA loopback output feature, it allows the system to be used as a KVM switch. Adding extra devices allows the user to cascade the system enabling them to extend the transmission distance without signal loss or introducing perceivable delay.

Control is via Telnet, IR Remote, WebGUI and RS-232 commands with On-screen Display (OSD) feedback messaging.

2. APPLICATIONS

- /// HDMI, USB, Audio, IR, and RS-232 extension
- /// Broadcasting a system over a single Cat.5e/6 cable
- /// Multimedia display on a large number of displays via multicast
- /// Hotel or convention center display multi-monitor broadcast
- /// Long distance data and video transmission via cascading
- /// Distributed video matrix system
- /// Distributed video wall system
- /// Remote KVM control of a system

3. PACKAGE CONTENT

- /// 1× HDMI over IP Transmitter with USB/KVM Extension
- /// 1× 5V/2.6A DC Power Adaptor
- /// 1× IR Extender Cable
- /// 1× IR Blaster Cable
- /// 1× Operation Manual

4. SYSTEM REQUIREMENTS

- /// HDMI source equipment such as a media player, video game console, PC, or set-top box.
- /// A Gigabit Ethernet network switch with jumbo frame support is required for multi-unit configurations. (8K jumbo frames are strongly recommended.)
- /// A Gigabit Ethernet switch with “IGMP snooping” enabled is required for multicast support.
- /// The use of Premium High Speed HDMI cables, and industry standard Cat.6, Cat.6A, or Cat.7 Ethernet cable is highly recommended.

5. FEATURES

- /// HDMI 2.0 and DVI 1.0 compliant
- /// HDCP 1.4 & 2.2 compliant
- /// 1×HDMI input
- /// Video, audio, and control transmission over TCP/IP in unicast (point-to-point) or multicast (single-to-many) modes
- /// HDMI input supports resolutions up to 4K@60Hz (4:4:4, 8-bit)
Note: 4K@50/60Hz (4:2:0) sources are automatically converted to 4K@25/30Hz (RGB) and 4K@50/60Hz (4:4:4) sources are automatically converted to 1080p@50/60Hz (RGB) prior to transmission from the transmitter.
- /// Supports the extension of many audio formats including 8 channel LPCM and standard Bitstream
- /// Supports independent breakaway A/V and control matrix routing
- /// The analogue Line In can be automatically embedded into the streaming output and can be independently routed to any receiver
- /// May be powered directly by PoE when connected to a Gigabit Ethernet switch that provides PoE (802.3af)
- /// Supports USB host device extension allowing the remote connection of a keyboard, mouse or storage
- /// Supports IR and RS-232 bypass
- /// Supports the use of an external control center (IP Master Controller) to provide expanded functionality (Contact your authorised dealer for more information)
- /// Basic control via front panel buttons, or can be fully controlled via WebGUI, IP Master Controller, and Telnet

6. OPERATION CONTROLS AND FUNCTIONS

6.1 Transmitter's Front Panel

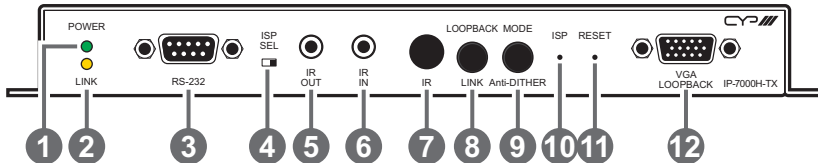

- 1 **POWER LED:** This LED will flash while the unit is powering on and will illuminate solidly once it is ready to be used.
- 2 **LINK LED:** If the transmitter has no network connection the LINK LED will not illuminate. While the transmitter is attempting to establish a connection with a receiver the LINK LED will flash. When the transmitter has established a stable connection with a receiver the LINK LED will illuminate solidly.
- 3 **RS-232 IN Port:** Connect directly to your PC/laptop to send commands to RS-232 devices connected to the currently routed receiver. The baud rate is configurable, but the default baud rate is 115200.

Note: When the transmitter is in multicast mode every connected receiver unit can send RS-232 commands to the transmitter and commands sent from the transmitter side will be sent to all associated receivers.

- 4 **ISP SEL Switch:** This is for factory use only.
Note: By default this is set to the right (away from the RS-232 port) and allows normal RS-232 functionality. Setting this switch to the left enables ISP engineering mode.
- 5 **IR OUT Port:** Connect to the provided IR Blaster to transmit IR signals sent from the associated receiver to devices within direct line-of-sight of the IR Blaster.
- 6 **IR IN Port:** Connect to the provided IR Extender to extend the IR control range of remotely located devices. Ensure that the remote being used is within direct line-of-sight of the IR Extender.
Note: When the transmitter is in multicast mode the IR signal is sent to all associated receivers.
- 7 **IR Window:** Accepts IR signals from any standard remote control and sends the signal to the IR Out on the associated receiver.
Note: When the transmitter is in multicast mode the IR signal is sent to all associated receivers.

- 8 LOOPBACK/LINK Button:** This button controls the following functions:
- **Loopback:** Press this button momentarily to toggle the VGA loopback function on and off, allowing you to locally monitor non-HDCP HDMI sources (1080p or below) for troubleshooting purposes.
 - **Video Link:** Press and hold the button for 3 seconds to enable or disable the streaming link with the currently routed receiver. When the link is disabled, and the receiver is connected to a display, it will show the system's current IP and firmware information.
 - **Reset to Factory Defaults:** Press and hold this button when powering the unit on until both the POWER and LINK lights are blinking. Once both lights are blinking you can reboot the unit and all settings will be returned to the factory defaults (Including resetting the IP mode to auto, broadcast channel to 0, and the streaming mode to multicast). A new IP address will be assigned automatically within the 169.254.xxx.xxx address range.
- 9 MODE/Anti-DITHER Button:** This button controls the following functions:
- **Video Mode:** Press this button momentarily to toggle the video data streaming method between "Graphic" and "Video" modes. "Graphic" mode is optimised for high-detail static displays and "Video" mode is optimised for full motion video.
 - **Anti-Dither:** Press and hold this button for 3 seconds to switch between the three "Anti-Dither" modes (1-bit, 2-bit, and off).
Note: Certain graphics cards use dithering to emulate a larger colour palette, but dithering causes difficulty for maintaining low-bandwidth during real-time video compression. These modes are designed to remove the dithering prior to compression and transmission of the signal. The Anti-Dither feature is set to "off" by default. If the source is not using dithering, please leave this feature disabled as it may cause a blocking effect with non-dithered content.
- 10 ISP Pinhole:** This is for factory use only.
- 11 RESET Pinhole:** Press this recessed button to reset the unit's power supply and reboot the unit.
Note: Settings will not be reset.
- 12 VGA LOOPBACK Port:** Connect to an analogue VGA monitor to locally view the connected HDMI (non-HDCP, 1080p or lower) source.

6.2 Transmitter's Rear Panel

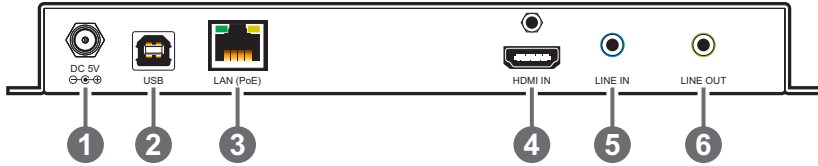

- 1 **DC 5V Port:** Plug the 5V DC power adapter into the unit and connect it to an AC wall outlet for power.

Note: Optional, not needed if the unit is powered by PoE.

- 2 **USB (Type-B) Port:** Connect directly to a PC or laptop to extend its USB functionality to the Type-A ports on the connected receiver.
- 3 **LAN (PoE) Port:** Connect via a Gigabit Ethernet switch to compatible receiver(s) to transmit data, and to a PC/laptop to control the unit via WebGUI.

Note: This unit can be powered directly by the connected Gigabit Ethernet switch if it provides PoE (802.3af).

- 4 **HDMI IN Port:** Connect to HDMI source equipment such as a media player, game console, or set-top box.
- 5 **LINE IN Port:** Connect to the analogue stereo output of a device such as a PC, laptop, or audio player.
- 6 **LINE OUT Port:** Connect to powered speakers or an amplifier for mono analogue audio output. This will output the audio from the Mic In on the currently routed receiver.

Note: This function is only available in unicast mode. The Mic In audio channel from the receiver is only active when an analogue source is also connected to the Line In port on the transmitter.

6.3 IR Cable Pinouts

IR Blaster Cable

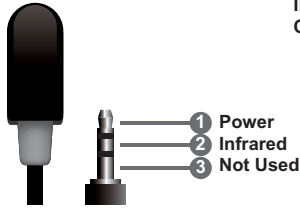

IR Extender Cable

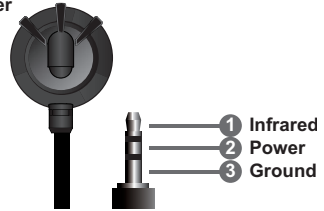

6.4 Serial Pinout and Defaults

Serial Port Default Settings	
Baud Rate	115200
Data Bits	8
Parity Bits	None
Stop Bits	1
Flow Control	None

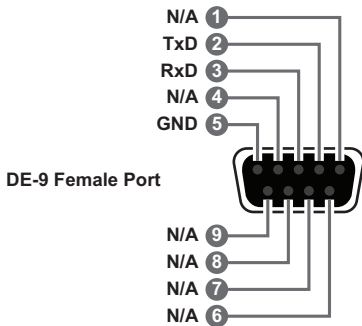

6.5 WebGUI Control

/// Device Discovery

Please obtain the “Device Discovery” software from your authorised dealer and save it in a directory where you can easily find it.

Connect the unit and your PC/Laptop to the same active network and execute the “Device Discovery” software. Click on “Find Devices on Internet” and a list of devices connected to the local network will show up indicating their current IP address.

Note: This unit defaults to Auto IP mode. The current IP address can be verified via the receiver’s OSD if the Device Discovery software is not available.

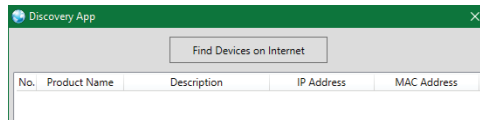

By clicking on one of the listed devices you will be presented with the network details of that particular device.

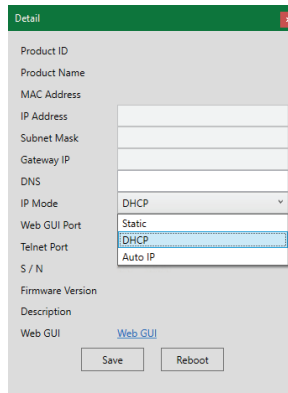

- 1) **IP Mode:** If you choose, you can alter the static IP network settings for the device, or switch the unit into DHCP mode to automatically obtain proper network settings from a local DHCP server. To switch to DHCP mode, please select DHCP from the IP mode drop-down, then click “Save” followed by “Reboot”.
- 2) **WebGUI Hotkey:** Once you are satisfied with the network settings, you may use them to connect via Telnet or WebGUI. The network information window provides a convenient link to launch the WebGUI directly.

/// WebGUI Overview

All major functions of the unit, including status, streaming method, streaming channel selection, output resolution, video wall configuration, EDID management, Ethernet settings, and reset/firmware functions are controllable via multiple tabs in the WebGUI interface allowing for reasonably intuitive operation.

Each transmitter, receiver, or transceiver is controlled by its own WebGUI interface which may be accessed by opening a standard web browser on a PC and typing in the IP address of the unit you wish to connect to. On a transceiver unit, the IP address of a unit can be obtained simply by checking the information screen within the OSD menu, accessed by pressing the menu button.

On stand-alone transmitters/receivers you can discover the IP address by checking the status OSD that is displayed when there is no live video source or no live link. Breaking the link is accomplished by pressing and holding the “LINK” button on the front of the unit for 3 seconds (The LINK light will blink rapidly, then turn off). Once the link is broken, each connected receiver will output a 640×480 black screen with OSD text at the bottom identifying its own IP address (Local IP), as well as the IP address of the transmitter (Remote IP) that shares the same broadcasting channel with it (channel 0 by default). After obtaining the IP address information, press and hold the “LINK” button again for 3 seconds to return the unit to normal operation (The LINK light will light up solid yellow).

```
FW: 15-Nov-10 4298
Local IP: 169.254.9.180
Remote IP: 169.254.11.173
ID: FFFFFFFF
```

After connecting to a unit’s WebGUI, you will find a screen containing multiple tabs for each functionality area of the unit. The individual tabs and functions will be introduced in the following sections.

Note: AVoIP streaming uses a large amount of bandwidth (especially at higher resolutions) and a Gigabit Ethernet network switch with jumbo frame support and IGMP snooping is required. A professional managed switch with VLAN support is strongly recommended. Please note that most consumer-grade routers are not able to handle the high traffic rates generated by multicast mode, so using a router directly as your network switch is discouraged. It is strongly suggested to avoid mixing your regular network traffic with AVoIP streaming traffic and the AVoIP traffic should exist within a separate subnet, at the minimum.

6.5.1 System Tab

The System tab contains 4 windows that provide access to firmware version information, a firmware update interface, utilities for rebooting and resetting the unit, basic EDID management, Telnet command entry, and a variety of statistics and information about the operational state of the unit.

- 1) **Version Information:** This window displays detailed information about the current firmware version.

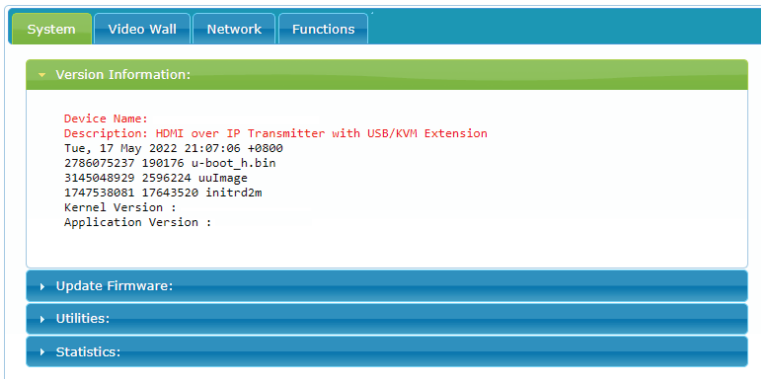

- 2) **Update Firmware:** Provides a way to update the unit's firmware. Click "Choose File" to select the firmware update file from the local PC (*.bin format). After selecting an appropriate file, click the "Upload" button to begin the update process.

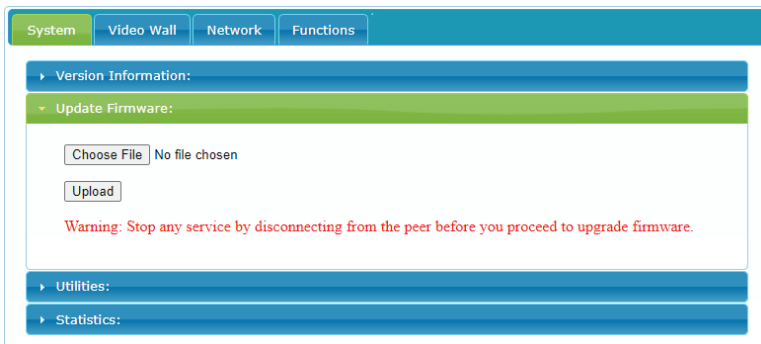

- 3) Utilities:** The Utilities window allows users to reset the unit back to the factory defaults by clicking “Factory Default”. The unit may be rebooted (without resetting settings) by pressing the “Reboot” button.

Note: Enable Log Messages is for troubleshooting purposes and should only be checked if instructed to do so by technical support.

If the EDID received from the primary receiver unit (selected via a checkbox on the preferred receiver in multicast mode) has compatibility issues with the connected HDMI source, the default HDMI EDID (up to 4K30 w/audio) can be applied. Please press “Apply” to activate it.

Note: This EDID setting will be reset if the unit is rebooted.

The screenshot shows a web interface with a top navigation bar containing tabs for "System", "Video Wall", "Network", and "Functions". Below this, there are expandable sections: "Version Information:", "Update Firmware:", and "Utilities:". The "Utilities:" section is highlighted in green and contains a "Commands" section. Inside "Commands", there is a checkbox for "Enable Log Message" which is currently unchecked. Below it are two buttons: "Factory Default" and "Reboot". Further down is the "Reset EDID to Default Value:" section, which has a radio button selected for "Default HDMI EDID" and an "Apply" button to its right. Below that is the "Console API Command" section, featuring a text input field and an "Apply" button. Underneath is an "Output" section with a large text area for displaying responses. At the bottom of the "Utilities" section is a "Statistics:" section, which is currently collapsed.

Finally, individual Telnet commands may be sent to the unit by using the “Console API Command” text entry field and pressing “Apply”. Any responses from the unit will be displayed in the “Output” field.

- 4) Statistics:** The Statistics window shows all available information about

the operational status of the unit, including current Host ID Name, serial number, Ethernet information, MAC address, unicast/multicast mode, link status and mode.



The screenshot displays a web interface with a navigation bar at the top containing 'System', 'Video Wall', 'Network', and 'Functions'. The 'System' tab is active. Below the navigation bar, there are several expandable sections: 'Version Information', 'Update Firmware', 'Utilities', and 'Statistics'. The 'Statistics' section is expanded, showing two sub-sections: 'State Machine' and 'Network'. The 'State Machine' section displays 'State: s_srv_on'. The 'Network' section displays the following information: ID (Host Name): 1, IP Address: 192.168.10.118, Subnet Mask: 255.255.255.0, Default Gateway: 192.168.10.1, MAC Address: (blank), Casting Mode: Multicast Mode, Link Status: on, Link Mode: 1G, and S/N: (blank).

System | Video Wall | Network | Functions

- ▶ Version Information:
- ▶ Update Firmware:
- ▶ Utilities:
- ▶ Statistics:

State Machine

State: s_srv_on

Network

ID (Host Name): 1
IP Address: 192.168.10.118
Subnet Mask: 255.255.255.0
Default Gateway: 192.168.10.1
MAC Address:
Casting Mode: Multicast Mode
Link Status: on
Link Mode: 1G
S/N:

6.5.2 Video Wall Tab

The Video Wall tab allows user to design, edit and manipulate a video wall system created using multiple receiver units connected to identical displays. The bezel and video size of the displays being used, as well as the horizontal and vertical monitor count, is defined here. Video stretch and rotation can also be controlled on this tab. Receivers in the video wall's group (all receivers sharing the same channel) can be controlled by any other unit within the same group.

Note: The Video Wall tab is accessible on both transmitters and receivers, however video wall settings may only be applied to receiver units.

System
Video Wall
Network
Functions

Basic Setup:

Bezel and Gap Compensation

OW:

OH:

VW:

VH:

UNIT: 0.1mm

Apply To: "All" device(s) in the list

All
Apply

Wall Size and Position Layout

Vertical Monitor Count:

Horizontal Monitor Count:

Row Position:

Column Position:

UNIT: Panel

Preferences

Stretch Type:

Clockwise Rotate:

Apply To:

Show OSD

Apply

When saving changes on the Video Wall tab, remember to select the appropriate “Apply To:” target unit before pressing the “Apply” button. On transmitters, settings may only be applied to remote receivers within the same video wall group. Select the IP address of the receiver (Client) you want to apply changes to from the “Apply To:” drop down or select “All” to send the changes to all receivers in the group.

Note: Video walls can only be generated when all associated units are in multicast mode.

- 1) Bezel and Gap Compensation:** This section of the Video Wall tab is used to define the physical dimensions of each display being used in the video wall. Accurate measurements are needed of the monitor’s outer frame (OW, OH) and the video screen (VW, VH). The measurements may be made using any unit format (inches, mm, cm, etc.) as long as ALL measurements in the same wall are made using the exact same units and the numbers are integers.

Bezel and Gap Compensation

OW:

OH:

VW:

VH:

Apply To: "All" device(s) in the list

UNIT: 0.1mm

- **OW (Outer Width):** This is the horizontal measurement of the display’s outer case.
- **OH (Outer Height):** This is the vertical measurement of the display’s outer case.
- **VW (Video Width):** This is the horizontal measurement of the display’s video screen.
- **VH (Video Height):** This is the vertical measurement of the display’s video screen.

Note: Typically all monitors in a video wall are identical and have the

same dimensions, but it is possible to use differently sized displays as long as the same measurement units are used to measure each display and the displays are still arranged in a normal rectangular layout with corners meeting at the same place.

- **Apply To:** Select which unit(s) to send updated settings to when “Apply” is pressed.
 - Selecting “All” will direct updates to the video wall Bezel settings of all units in the current video wall group (transmitter and receivers).
 - Selecting an IP address from the “Clients” list will direct updates to the video wall settings of the receiver with that IP address.

2) Wall Size and Position Layout: This section of the Video Wall tab is used to define the number of displays used in the video wall as well as the location of the specific display within the video wall. A typical video wall consists of an equal number of horizontal and vertical monitors (for example: 2×2 or 3×3), however it is possible to create video walls using this system with a wider variety of dimensions as long as the end result is still a rectangle (for example: 5×1 or 2×3). Both horizontal and vertical dimensions are limited to a maximum of 16 displays.

Wall Size and Position Layout

Vertical Monitor Count:

Horizontal Monitor Count:

Row Position:

Column Position:

- **Vertical Monitor Count:** Define the number of displays in the video wall, measured vertically. (Maximum is 16 displays)
- **Horizontal Monitor Count:** Define the number of displays in the video wall, measured horizontally. (Maximum is 16 displays)
- **Row Position:** Set the vertical location of the currently controlled display. (Counts top to bottom, from 0 to 15)
- **Column Position:** Set the horizontal location of the currently controlled display. (Counts left to right, from 0 to 15)

- 3) **Preferences:** This section of the Video Wall tab provides additional controls over how the source video is displayed on the video wall as well as providing a drop down to determine which receiver to apply changed settings to.

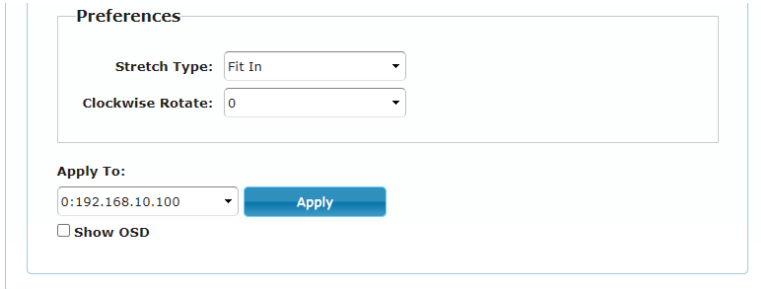

The screenshot shows a 'Preferences' panel with the following elements:

- Stretch Type:** A dropdown menu currently set to 'Fit In'.
- Clockwise Rotate:** A dropdown menu currently set to '0'.
- Apply To:** A dropdown menu currently set to '0:192.168.10.100'.
- Apply:** A blue button to apply the settings.
- Show OSD:** An unchecked checkbox.

- **Stretch Type:** Set the video stretch method.
 - Selecting “Fit In” will expand the video to exactly fit the dimensions of the video wall regardless of the source’s original aspect ratio.
 - Selecting “Stretch Out” will zoom the video until the video wall is filled in all 4 dimensions while maintaining the aspect ratio of the original source.
- **Clockwise Rotate:** Set the rotation of the video output to 0, 180 or 270 degrees.
- **Apply To:** Select which unit(s) to send updated settings to when “Apply” is pressed.
 - Selecting an IP address from the “Clients” list will direct updates to the video wall settings of the receiver with that IP address.
- **Show OSD:** Enables or disables the OSD display of the current channel selection.

Note: When setting up a new video wall, or changing the configuration of an existing one, remember to update the configuration of each receiver in the system.

6.5.3 Network Tab

The Network tab provides controls over the transmitter's broadcast channel, IP configuration, and network broadcast mode. Changes made to the network settings will require a reboot of the unit. After clicking on "Apply" please follow the reboot instructions in the WebGUI.

Note: If the IP address is changed then the IP address required for WebGUI access will also change accordingly. If the new address is assigned via "Auto IP" or "DHCP" it might be necessary to temporarily disable the Video Link between the receiver and transmitter in order to display the units' new IP addresses on the receiver's HDMI output. Press and hold the LINK button for 3 seconds to enable or disable the Video Link.

System **Video Wall** **Network** Functions

Channel Setup

Channel Selection: 1

IP Setup

IP Mode: Auto IP DHCP Static

IP Address: 169.254.xxx.xxx (Auto)

Subnet Mask: 255.255.0.0

Default Gateway: 172.16.200.254

Find Your Device: Hide Me Show Me

Casting Mode

Multicast Unicast

- 1) **Channel Setup:** Use the dropdown to select the broadcast channel for the transmitter. All receivers on the local network that are set to the same channel will receive video from this transmitter. The available channel range is from 0 to 255.

Note: Every transmitter within the same local network must be assigned a different broadcast channel in order to avoid conflicts.

- 2) **IP Setup:** This section allows for configuration of the IP acquisition mode and Ethernet settings of the unit. It also provides an easy way to find the physical unit when installed with many other similar units.

- **IP Mode & Settings:** The IP mode may be switched between “Auto IP”, “DHCP” or “Static IP”. When the unit is set to Auto IP mode it will automatically assign itself an APIPA address from the 169.254.xxx.xxx range. When the unit is set to DHCP mode it will attempt to automatically obtain an IP address from a DHCP server. When the IP mode is set to static IP, you can manually set the IP address, netmask and gateway address. Click the “Apply” button to save changes made to the IP Mode or Configuration.

Note: The default network setting for this unit is “Auto IP”.

- **Find Your Device:** Selecting “Show Me” will cause the unit to immediately begin flashing the LEDs on the front of the unit to make it easy to find. Selecting “Hide Me” returns the LEDs to their normal behavior. This setting is useful when troubleshooting an installation with a large number of units in a rack.

- 3) **Casting Mode:** Allows for the selection of the broadcasting mode used by the transmitter. Click the “Apply” button to save changes made to the broadcasting mode.

Note: Receivers must be set to the same mode as the transmitter in order to receive video.

- **Multicast:** This mode sends a single video stream that can be viewed simultaneously by multiple receivers without increasing bandwidth usage. This mode is ideal for video wall or matrixing scenarios. Multicast mode requires a network switch with IGMP snooping enabled.

Note: The 3 port network switch built into the receiver units supports IGMP snooping and may be used to distribute a multicast stream.

- **Unicast:** This mode uses a discrete video stream for every connected receiver and is ideal for simple, point-to-point, streaming setups. This mode does not require a network switch that supports IGMP snooping, however connecting a single source to multiple receivers is not supported.

6.5.4 Functions Tab

The Functions tab provides control over the transmitter’s streaming bandwidth/quality settings, as well as a wide variety of optional features and functions, including USB and serial control extension. Changes made to these settings typically require a reboot of the unit. After clicking on “Apply” please follow the reboot instructions in the WebGUI, if necessary.

- 1) **Video over IP:** This section allows control over video streaming bit rate and quality.

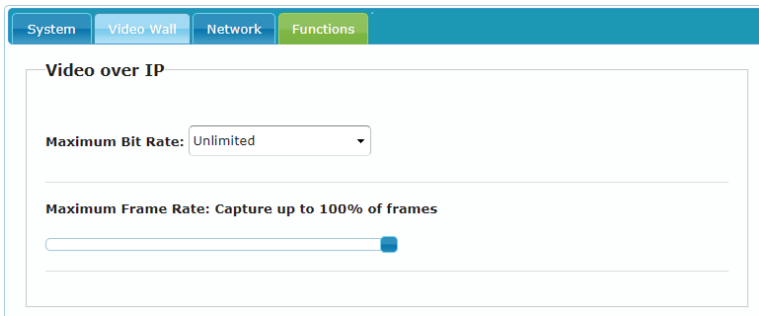

- **Maximum Bit Rate:** Set the maximum bit rate that can be used to the output video stream. Available options are: Unlimited, 400Mbps, 200Mbps, 100Mbps, 50Mbps. Selecting “Unlimited” will use up to the maximum available bandwidth in order to maintain a full framerate video stream.

Note: While it is generally suggested to select “Unlimited” when streaming 4K video sources, the amount of bandwidth required can be very large and will limit the number of concurrent video streams.

- **Maximum Framerate:** Adjusting this slider will set the percentage of frames from the source video to encode (2-100%). This is ideal for reducing the bandwidth requirements of high-resolution, but limited motion, sources such as slide presentations or information screens.

Note: If the framerate is lowered too far with high motion video sources, the video will become noticeably choppy.

- 2) **Audio over IP:** The audio source to embed with the video source in the outbound AVoIP stream is selected here. Selecting “Auto” will automatically switch to the detected audio source with priority given to “Line In”. Selecting “HDMI” will embed the current HDMI video’s audio source, selecting “Line In” will embed the Line In audio source.

Audio over IP

Auto

HDMI

Line In

Note: By default, audio will be set to “AUTO” mode.

- 3) **USB over IP:** This section provides controls for the USB over IP extension functionality and enabling various USB compatibility settings.

USB over IP

Operation Mode:

Auto select mode (Recommended, choose per network casting mode)

Active on link (Unicast network's default mode)

Active per request (Multicast network's default mode)

Compatibility Mode:

Mouse not responding well (Check when USB mouse responding is slow and queer)

K/M over IP (Uncheck when mouse/keyboard/touch panel not working as expected)

Apply

- **Operation Mode:** Sets the USB extension mode. Available options are Auto, Active on link (Unicast optimised), and Active per request (Multicast optimised). Auto mode is set by default and will automatically select the correct mode depending on the broadcast mode of the unit.
- **Compatibility Mode:** These troubleshooting options enable specialised optimizations to solve issues when a mouse or touch panel is not responding properly. They should normally be left unchecked.

- 4) **Serial over IP:** This section provides controls for the serial over IP extension functionality by setting the RS-232 data configuration.

Serial over IP

Baudrate: 115200 ▼

Data bits: 8 ▼

Parity: None ▼

Stop bits: 1 ▼

[Apply](#)

[Reboot](#)

- **Serial Settings:** Set the desired baud rate, data bits, parity, and stop bit for the RS-232 signal to extend.

Note: The transmitter and receiver must have the same serial settings.

- 5) **Reboot:** Pressing this button will force the unit to reboot.

6.6 Telnet Control

Before attempting to use Telnet control, please ensure that both the unit and the PC are connected to the same active networks.

Start your preferred Telnet/Console client, or use the built in client provided by most modern computer operating systems. After starting the client, connect by using the current IP address of the unit and port 23 (if the communication port number used by the unit has not been changed previously). This will connect us to the unit we wish to control and commands may now be entered directly.

Note 1: If the IP address of the unit is changed then the IP address required for Telnet access will also change accordingly.

Note 2: This unit defaults to Auto IP mode. The current IP address can be verified via the receiver's OSD if the Device Discovery software is not available. The default communication port is 23.

6.7 Serial and Telnet Commands

COMMAND
Description and Parameters
help ↵
Show the full command list.
help N1 ↵
Show help details about the specified command. N1 = {Any command name}
get_ipconfig ↵
Show the current IP configuration.

COMMAND	
Description and Parameters	
set_ip_mode N1 ↵	
Set the IP configuration mode.	
Available values for N1 :	
0	[Static IP Mode]
1	[DHCP Mode]
2	[Auto IP Mode]
get_ip_mode ↵	
Show the current IP configuration mode	
set_ip_address N1 ↵	
Set the static IP address.	
N1 = X.X.X.X	[X = 0~255, IP Address]
get_ip_address ↵	
Show the current IP address.	
set_netmask N1 ↵	
Set the Ethernet netmask.	
N1 = X.X.X.X	[X = 0~255, Netmask]
get_netmask ↵	
Show the current Ethernet netmask.	
set_gateway N1 ↵	
Set the IP gateway address.	
N1 = X.X.X.X	[X = 0~255, Gateway address]
get_gateway ↵	
Show the current gateway address.	

COMMAND	
Description and Parameters	
set_net_mode N1 ←	
Set the network broadcast mode.	
Available values for N1 :	
0	[Unicast Mode]
1	[Multicast Mode]
get_net_mode ←	
Show the current network broadcast mode.	
set_jumbo_mtu N1 ←	
Enable/disable the jumbo frame MTU.	
Available values for N1 :	
0	[Disabled]
1	[Enabled]
get_jumbo_mtu ←	
Show the jumbo frame MTU state.	
get_hardware_version ←	
Show the current hardware version.	
factory_reset N1 ←	
Perform a factory reset on the unit and select the IP mode after the reset completes.	
Available values for N1 :	
0	[Reset into Static IP mode]
1	[Reset into Auto IP mode]
reboot ←	
Reboot the unit.	

COMMAND	
Description and Parameters	
set_tx_channel N1 ↵	
Set the VoIP transmission channel.	
N1 = 0~255	[Transmission channel]
get_tx_channel ↵	
Show the current VoIP transmission channel.	
set_quality N1 ↵	
Set the Tx video optimization mode.	
Available values for N1 :	
0	[Graphic optimised mode]
1	[Video optimised mode]
get_quality ↵	
Show the current Tx video optimization mode.	
set_hdcp_allow N1 ↵	
Enable/disable HDCP encrypted source support.	
Available values for N1 :	
0	[Disabled]
1	[Enabled]
get_hdcp ↵	
Show the current HDCP support state.	
set_usb_mode ↵	
Set the USB extension mode.	
Available values for N1 :	
0	[Active on link]
1	[Active per request]
AUTO	[Auto select mode]

COMMAND	
Description and Parameters	
get_usb_mode ↵	Show the current USB extension mode setting.
set_usb_mouse N1 ↵	Set the USB mouse performance mode. Available values for N1 : 0 [High resolution mode] 1 [Compatibility mode]
get_usb_mouse ↵	Show the current USB mouse performance mode.
set_usb_kmoip ↵	Enable/disable keyboard & mouse compatibility mode. Available values for N1 : 0 [Disabled] 1 [Enabled]
get_usb_kmoip ↵	Show the current keyboard & mouse compatibility mode setting.
set_bandwidth N1 ↵	Set the broadcast stream bandwidth maximum. Available values for N1 : 0 [50 Mbps] 1 [100 Mbps] 2 [200 Mbps] 3 [400 Mbps] 4 [Unlimited]
get_bandwidth ↵	Show the unit's current bandwidth setting.

COMMAND	
Description and Parameters	
set_frame_rate N1 ←	
Set the frame rate percentage (in 1/60 steps) to use when encoding the source video.	
Available values for N1 :	
0	[Frame rate reduction disabled]
1~60	[Frame rate in 1/60 steps]
get_frame_rate ←	
Show the unit's current frame rate setting.	
set_vw_osd N1 {N2} ←	
Enable/disable video wall OSD to display the target receiver number on the designated display.	
Available values for N1 :	
0	[Disable]
1	[Enable]
N2 = 0~255	[Target Rx {Optional}]
<i>Note: The Target Rx number can be obtained by turning on the Video Wall OSD. Omitting N2 makes the setting global to all receivers.</i>	
set_vw_layout N1 N2 {N3} ←	
Set the video wall's total horizontal and vertical display count.	
N1 = 1~16	[Horizontal display count]
N2 = 1~16	[Vertical display count]
N3 = 0~255	[Target Rx {Optional}]
<i>Note: The Target Rx number can be obtained by turning on the Video Wall OSD. Omitting N3 makes the settings global to all receivers.</i>	

COMMAND

Description and Parameters

set_vw_pos N1 N2 {N3}←

Set the display's position within the video wall. (Cannot exceed the video wall's horizontal and vertical display count.)

N1 = 0~15 [Row]

N2 = 0~15 [Column]

N3 = 0~255 [Target Rx {Optional}]

*Note: The Target Rx number can be obtained by turning on the Video Wall OSD. Omitting **N3** makes the settings global to all receivers.*

set_vw_bc N1 N2 N3 N4 {N5}←

Set the video wall display's bezel compensation values.

N1 = 0~99999 [Video width]

N2 = 0~99999 [Total display width]

N3 = 0~99999 [Video height]

N4 = 0~99999 [Total display height]

N5 = 0~255 [Target Rx {Optional}]

*Note: The Target Rx number can be obtained by turning on the Video Wall OSD. Omitting **N3** makes the settings global to all receivers.*

set_vw_hscale N1 {N2}←

Set the video wall display's horizontal zoom amount.

N1 = 0~99999 [Zoom amount in 1 pixel units]

N2 = 0~255 [Target Rx {Optional}]

*Note: The Target Rx number can be obtained by turning on the Video Wall OSD. Omitting **N2** makes the settings global to all receivers.*

COMMAND**Description and Parameters****set_vw_vscale N1 {N2} ←**

Set the video wall display's vertical zoom amount.

N1 = 0~99999 [Zoom amount in 1 pixel units]

N2 = 0~255 [Target Rx {Optional}]

*Note: The Target Rx number can be obtained by turning on the Video Wall OSD. Omitting **N3** makes the settings global to all receivers.*

set_vw_shift N1 N2 {N3} ←

Set the video wall display's output shift.

Available values for **N1**:

U [Shift up]

D [Shift down]

L [Shift left]

R [Shift right]

N2 = 0~80000 [Pixel shift. Must be in increments of 8.]

N3 = 0~255 [Target Rx {Optional}]

*Note: The Target Rx number can be obtained by turning on the Video Wall OSD. Omitting **N3** makes the settings global to all receivers.*

COMMAND**Description and Parameters****set_serial_baud N1** ←

Set the serial baud rate.

Available values for **N1**:

0	[300 baud]
1	[600 baud]
2	[1200 baud]
3	[2400 baud]
4	[4800 baud]
5	[9600 baud]
6	[19200 baud]
7	[38400 baud]
8	[57600 baud]
9	[115200 baud]

get_serial_baud ←

Show the current serial baud rate.

set_serial_bits N1 ←

Set the number of serial data bits.

Available values for **N1**:

0	[5 bits]
1	[6 bits]
2	[7 bits]
3	[8 bits]

get_serial_bits. ←

Show the current number of serial data bits.

set_serial_parity N1 ←

Set the serial parity bit.

Available values for **N1**:

0	[None]
1	[Odd]
2	[Even]

COMMAND	
Description and Parameters	
get_serial_parity ↵	
Show the current serial parity bit.	
set_serial_stop N1 ↵	
Set the serial stop bits.	
Available values for N1 :	
0	[1 bit]
1	[2 bits]
get_serial_stop ↵	
Show the current serial stop bits.	
A N1 ↵	
Change audio input or currently connected source.	
Available values for N1 :	
D	[Digital]
A	[Analogue]
AUTO	[Auto]
get_A ↵	
Get current input audio status.	

Note: Commands will not be executed unless followed by a carriage return. Commands are not case-sensitive.

7. CONNECTION DIAGRAM

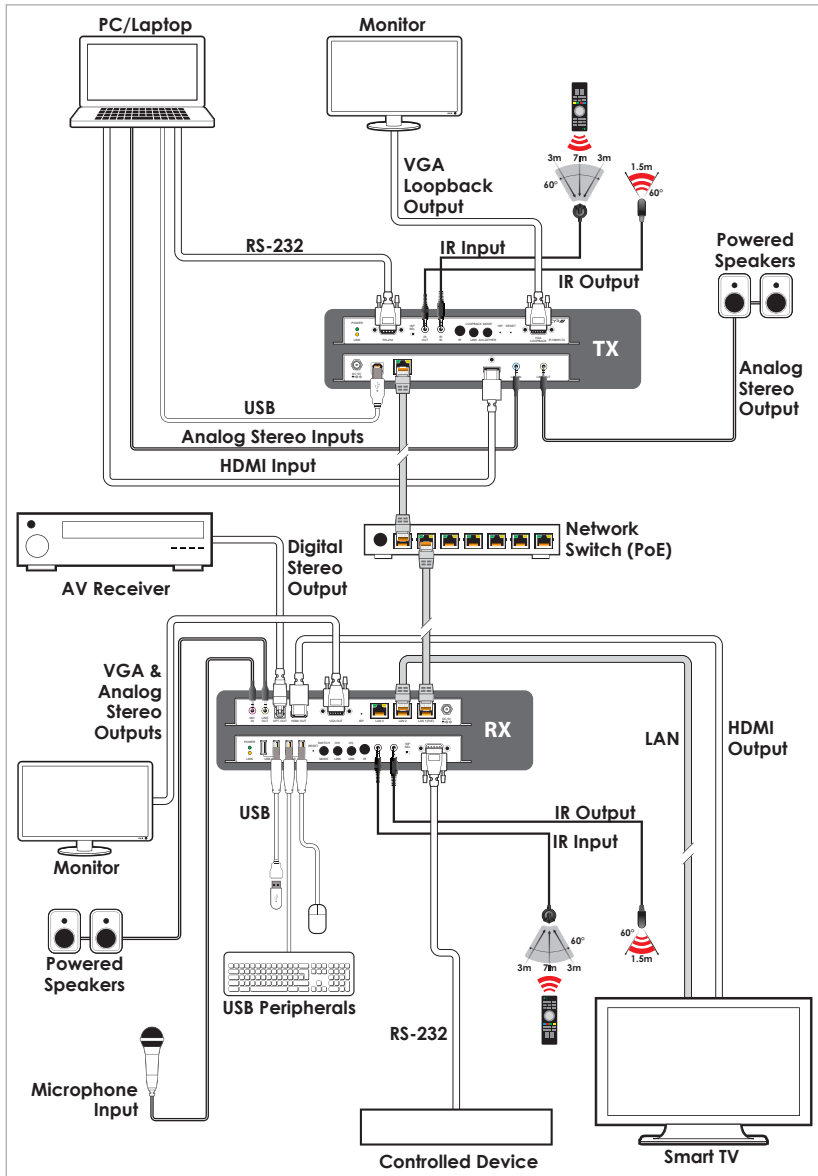

8. SPECIFICATIONS

8.1 Technical Specifications

HDMI Bandwidth	18Gbps
Input Ports	1×HDMI (Type-A) 1×Stereo Audio (3.5mm)
Output Port	1×Mono Audio (3.5mm)
Output/Control Port	1×LAN (RJ-45)
Pass-through Ports	1×IR Extender (3.5mm) 1×IR Blaster (3.5mm) 1×RS-232 (DE-9) 1×USB 2.0 (Type-B)
IR Frequency	30 ~ 50kHz (30 ~ 60kHz under ideal conditions)
Baud Rate	Up to 115200
Power Supply	PoE or 5V/2.6A DC (US/EU standards, CE/FCC/UL certified)
PoE Support	802.3af minimum
ESD Protection (HBM)	Human Body Model: ±12kV (Air Discharge) ±8kV (Contact Discharge)
Dimensions (W×H×D)	231.5mm×25mm×108mm [Case Only] 231.5mm×25mm×120mm [All Inclusive]
Weight	660g
Chassis Material	Metal (Aluminum)
Chassis Colour	Black
Operating Temperature	0°C - 40°C/32°F - 104°F
Storage Temperature	-20°C - 60°C/-4°F - 140°F
Relative Humidity	20 - 90% RH (Non-condensing)
Power Consumption	7.15W

8.2 Video Specifications

Supported Resolutions (Hz)	Input	Output
	HDMI	AVoIP
720x400p@70/85	✓	✓
640x480p@60/72/75/85	✓	✓
720x480i@60	✓	✓
720x480p@60	✓	✓
720x576i@50	✓	✓
720x576p@50	✓	✓
800x600p@56/60/72/75/85	✓	✓
848x480p@60	✓	✓
1024x768p@60/70/75/85	✓	✓
1152x864p@75	✓	✓
1280x720p@50/60	✓	✓
1280x768p@60/75/85	✓	✓
1280x800p@60/75/85	✓	✓
1280x960p@60/85	✓	✓
1280x1024p@60/75/85	✓	✓
1360x768p@60	✓	✓
1366x768p@60	✓	✓
1400x1050p@60	✓	✓
1440x900p@60/75	✓	✓
1600x900p@60RB	✓	✓
1600x1200p@60	✓	✓
1680x1050p@60	✓	✓
1920x1080i@50/60	✓	✓

Supported Resolutions (Hz)	Input	Output
	HDMI	AVoIP
1920×1080p@24/25/30	✓	✓
1920×1080p@50/60	✓	✓
1920×1200p@60RB	✓	✓
2560×1440p@60RB	×	×
2560×1600p@60RB	×	×
2048×1080p@24/25/30	×	×
2048×1080p@50/60	×	×
3840×2160p@24/25/30	✓	✓
3840×2160p@50/60 (4:2:0)	✓	×
3840×2160p@24, HDR10	×	×
3840×2160p@50/60 (4:2:0), HDR10	×	×
3840×2160p@50/60	✓	×
4096×2160p@24/25/30	✓	✓
4096×2160p@50/60 (4:2:0)	✓	×
4096×2160p@24, HDR10	×	×
4096×2160p@50/60 (4:2:0), HDR10	×	×
4096×2160p@50/60	✓	×

Note: 4K@50/60Hz (4:2:0) sources are automatically converted to 4K@25/30Hz (RGB) and 4K@50/60Hz (4:4:4) sources are automatically converted to 1080p@50/60Hz (RGB) prior to transmission from the transmitter.

8.3 Audio Specifications

8.3.1 Digital Audio

HDMI Input / AV over IP Output	
LPCM	
Max Channels	8 Channels
Sampling Rate (kHz)	32, 44.1, 48, 88.2, 96, 176.4, 192
Bitstream	
Supported Formats	Standard

8.3.2 Analogue Audio

Analogue Input	
Max Audio Level	2Vrms
Impedance	10k Ω
Type	Unbalanced
Analogue Output	
Max Audio Level	2Vrms
THD+N	< -80dB@0dBFS 1kHz (A-wt)
SNR	> 80dB@0dBFS
Frequency Response	< ± 1 dB@20Hz~20kHz
Crosstalk	< -80dB@10kHz
Impedance	470 Ω
Type	Unbalanced

8.3.3 AVoIP Audio Availability

Unicast Data Transmission Mode:

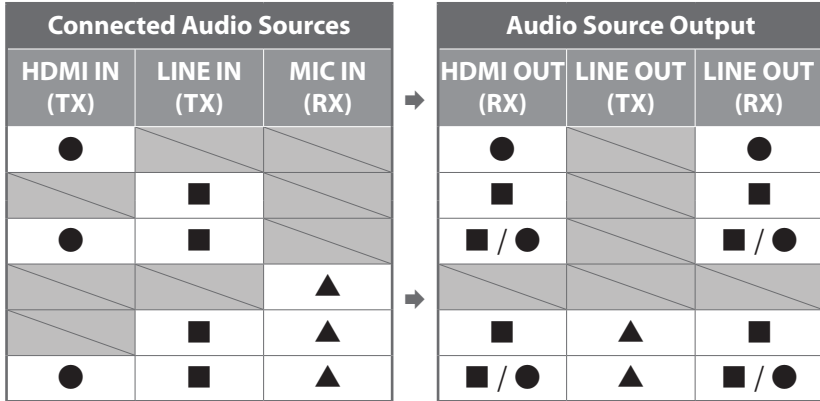

Multicast Data Transmission Mode:

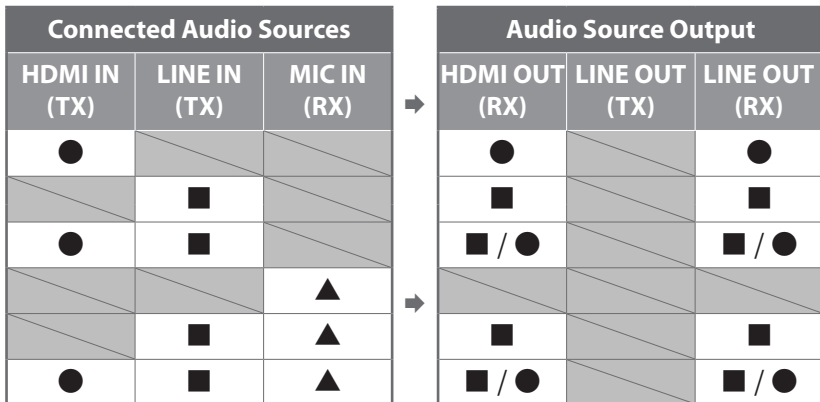

Legend:

- = HDMI audio source.
- = Line In (Transmitter) audio source.
- ▲ = Line In (Receiver) audio source.

8.4 Cable Specifications

Cable Length	HD	FHD	4K UHD	4K UHD ⁺	8K UHD
High Speed HDMI Cable					
HDMI Input	15m	10m	5m	3m	×
Ethernet Cable					
Cat.5e/6	100m			×	
Cat.6A/7	100m			×	

Bandwidth Category Examples:

/// HD Video

- 720p@60Hz
- HDMI transmission rates lower than 3Gbps
- HD-SDI (SMPTE 292M, 1.485Gbps)

/// FHD Video

- 1080p@60Hz
- HDMI transmission rates between 3Gbps and 5.3Gbps
- 3G-SDI (SMPTE 424M, 2.970Gbps)

/// 4K UHD Video

- 4K@24/25/30Hz (8-bit colour) & 4K@50/60Hz (4:2:0, 8-bit colour)
- HDMI transmission rates between 5.3Gbps and 10.2Gbps
- 6G-SDI (SMPTE ST 2081, 6Gbps)

/// 4K UHD⁺ Video

- 1080p@120Hz (10/12-bit HDR)
- 4K@50/60Hz (4:4:4, 8-bit) & 4K@50/60Hz (4:2:0, 10/12-bit HDR)
- HDMI transmission rates between 10.2Gbps and 18Gbps
- 12G-SDI (SMPTE ST 2082, 12Gbps)

/// 8K UHD Video

- 4K@120Hz (10/12-bit HDR)
- 8K@24/25/30Hz (10/12-bit HDR) & 8K@50/60Hz (4:2:0, 8-bit colour)
- HDMI transmission rates between 18Gbps and 48Gbps
- 24G-SDI (SMPTE ST 2083, 24Gbps)

9. ACRONYMS

ACRONYM	COMPLETE TERM
4K UHD	4K Ultra-High-Definition (10.2Gbps max)
4K UHD⁺	4K Ultra-High-Definition (18Gbps max)
8K UHD	8K Ultra-High-Definition (48Gbps max, without DSC)
8K UHD⁺	8K Ultra-High-Definition (48Gbps max, with DSC)
ADC	Analogue-to-Digital Converter
ASCII	American Standard Code for Information Interchange
AVoIP	Audio/Video over IP
Cat.5e	Enhanced Category 5 cable
Cat.6	Category 6 cable
Cat.6A	Augmented Category 6 cable
Cat.7	Category 7 cable
CLI	Command-Line Interface
DAC	Digital-to-Analogue Converter
dB	Decibel
DHCP	Dynamic Host Configuration Protocol
DVI	Digital Visual Interface
EDID	Extended Display Identification Data
GbE	Gigabit Ethernet
Gbps	Gigabits per second
GUI	Graphical User Interface
HDCP	High-bandwidth Digital Content Protection
HDMI	High-Definition Multimedia Interface
HDR	High Dynamic Range
IGMP	Internet Group Management Protocol

ACRONYM	COMPLETE TERM
IP	Internet Protocol
IR	Infrared
kHz	Kilohertz
KVM	Keyboard/Video/Mouse
LAN	Local Area Network
LED	Light-Emitting Diode
LPCM	Linear Pulse-Code Modulation
MAC	Media Access Control
MJPEG	Motion JPEG
MHz	Megahertz
OSD	On-Screen Display
PoE	Power over Ethernet
SNR	Signal-to-Noise Ratio
TCP	Transmission Control Protocol
THD+N	Total Harmonic Distortion plus Noise
TMDS	Transition-Minimised Differential Signaling
USB	Universal Serial Bus
VGA	Video Graphics Array
VLAN	Virtual LAN
VoIP	Video over IP
WUXGA (RB)	Widescreen Ultra Extended Graphics Array (Reduced Blanking)
XGA	Extended Graphics Array
Ω	Ohm



CYP (UK) Ltd., Unit 7, Shepperton Business Park, Govett Avenue,
Shepperton, Middlesex, TW17 8BA

Tel: +44 (0) 20 3137 9180 | Fax: +44 (0) 20 3137 6279

Email: sales@cypeurope.com

www.cypeurope.com

RDV1